

# OWNER'S MANUAL

SERIAL  
NUMBER

WRITE YOUR SERIAL NUMBER HERE.  
THE NUMBER IS LOCATED NEAR THE  
NAME PLATE ON THE UNIT'S REAR PANEL.

# ROTEL®

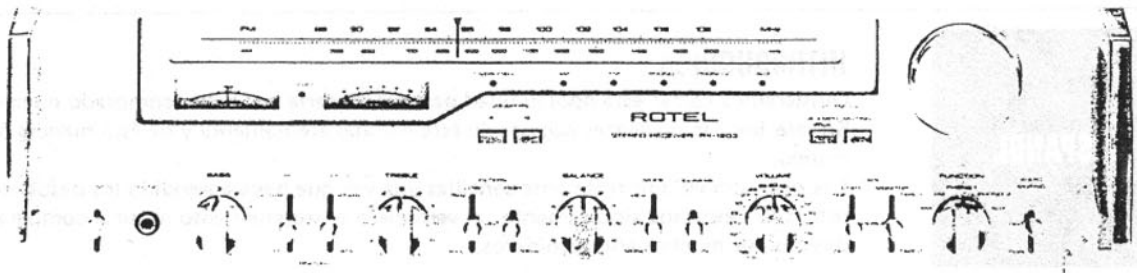

# RX-1203

## STEREO AM/FM RECEIVER

**WARNING:** To prevent fire or shock hazard, do not expose this appliance to rain or moisture.

Quality. Uncompromised.

# ROTEL

THE ROTEL CO., LTD.

1-36-8 Ohokayama, Meguro-ku, Tokyo, Japan

## BEFORE ENJOYMENT

For safety sake keep in mind the following cautions:

1. Do not connect the unit to the AC power line without speakers, turntable and other auxiliary components connected beforehand.
  2. Make sure also that the power switch is OFF and the volume control is set at minimum before plugging in the power cord to a wall outlet.
  3. Furnished Convenience AC Outlet
    - a) Do not insert or remove plug from any convenience AC outlet supplied on the appliance while the appliance is connected to power. Also do not insert foreign object, other than a proper plug, into the convenience AC outlet.
    - b) Do not connect other appliance(s) to convenience AC outlet if its/their total power consumption exceeds maximum rated watts labeled next to the outlet.
- Sound will not come out immediately after the power switch is pushed on due to the use of a protection relay against sudden loud noise.

## LOCATING THE UNIT

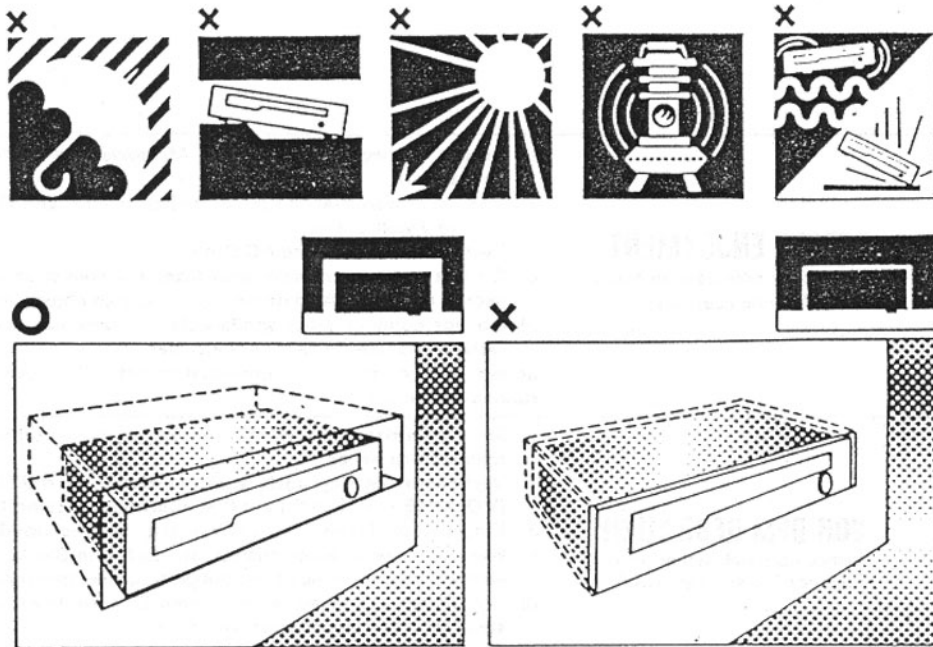

## SPEAKERS

- **Impedance** — Be sure to use speakers rated at 8 ohms or higher up to 16 ohms. In the event your speakers are rated at 4 ohms or lower than the desired 8 ohms, you may operate with one pair of such type of speakers at a time but never two pairs of speaker systems simultaneously. This measure is to prevent any severe overload and distortion from happening due basically to too low impedance to draw excessively high current. When you are uncertain on your speakers rating values, consult with the dealer or store you purchased.

## ● SPEAKERS CONNECTION

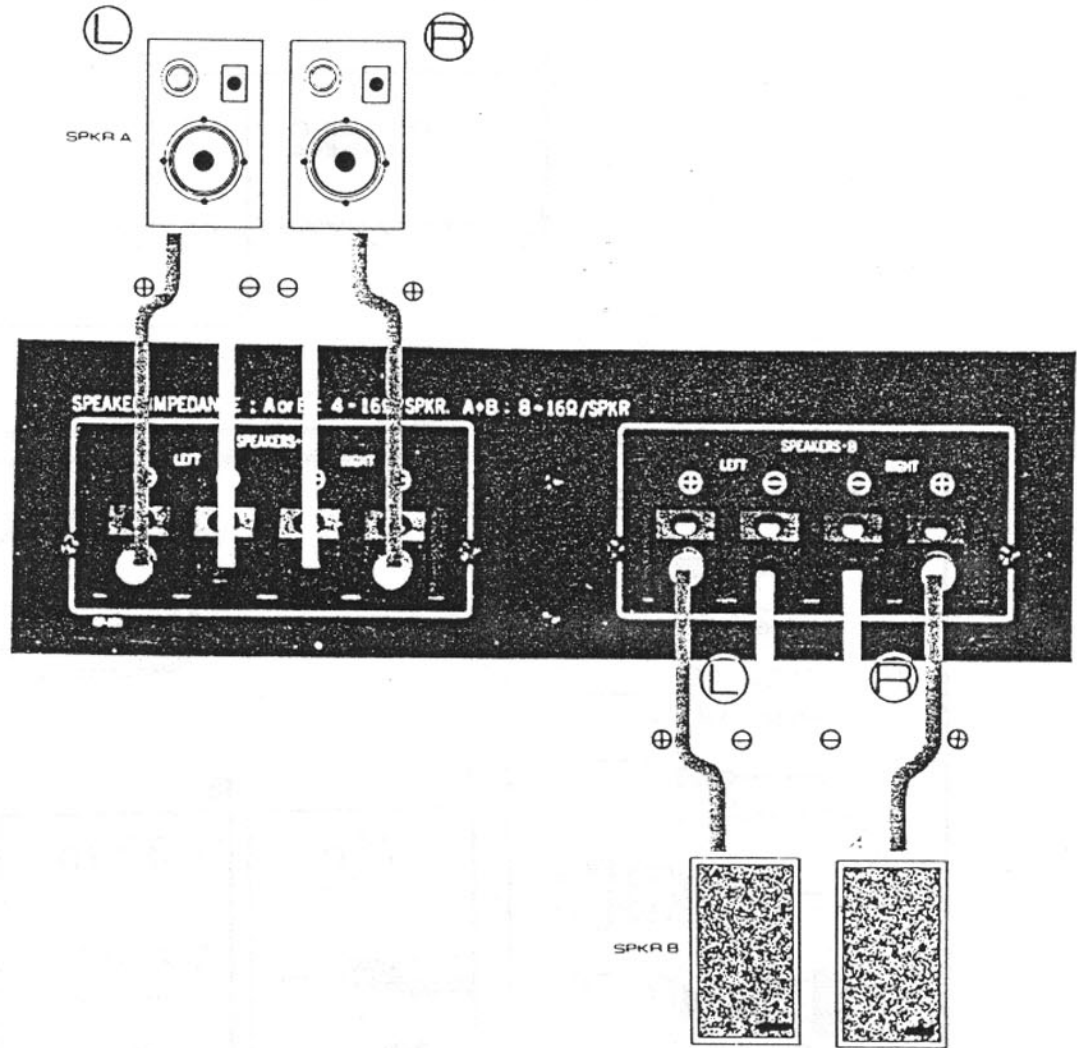
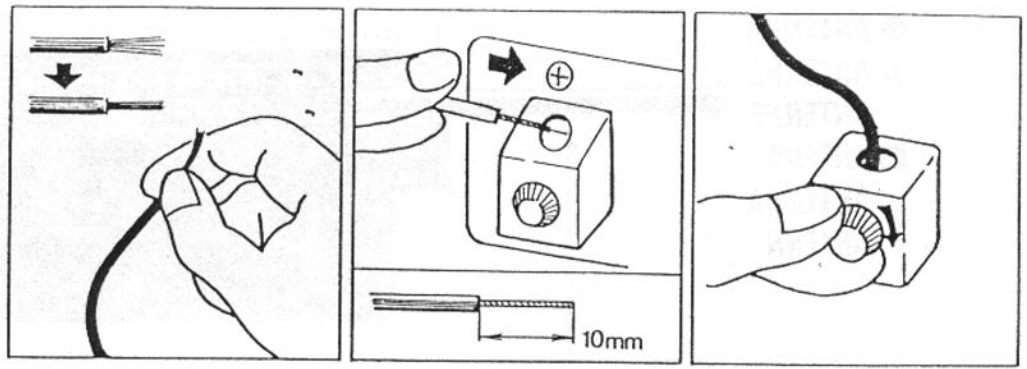

## ● SPEAKERS PLACEMENT

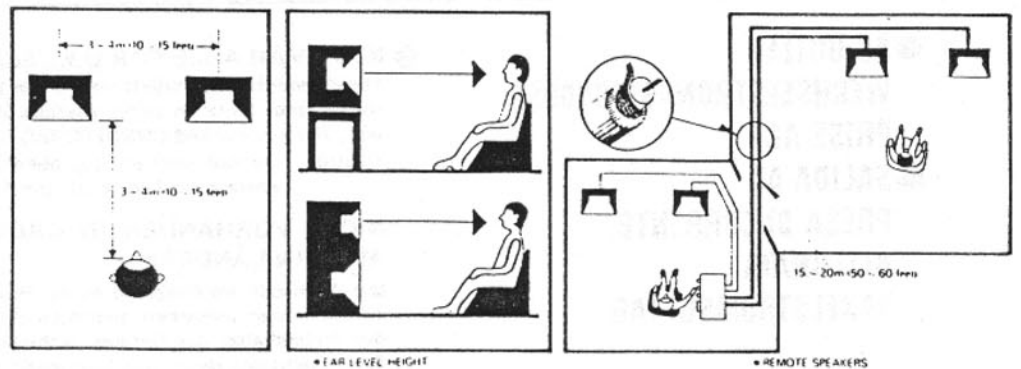

## ● ANTENNA

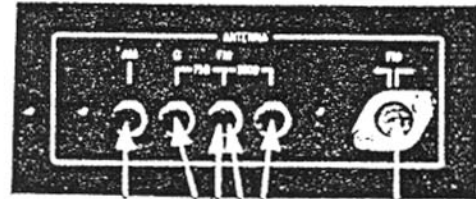
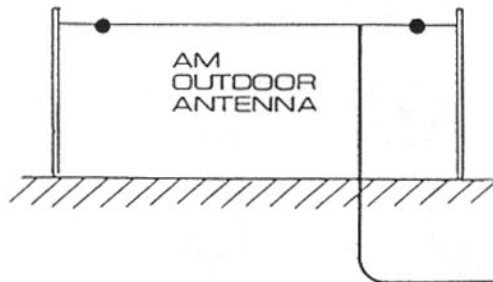
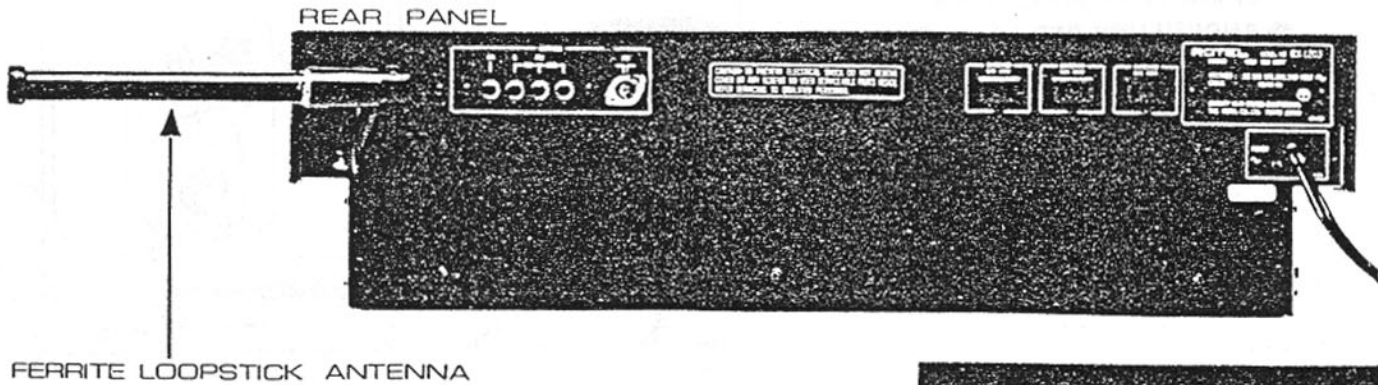

①

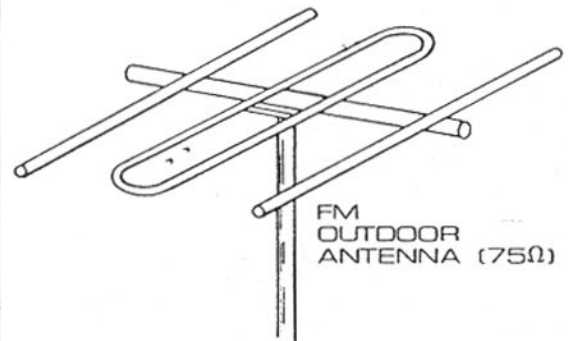
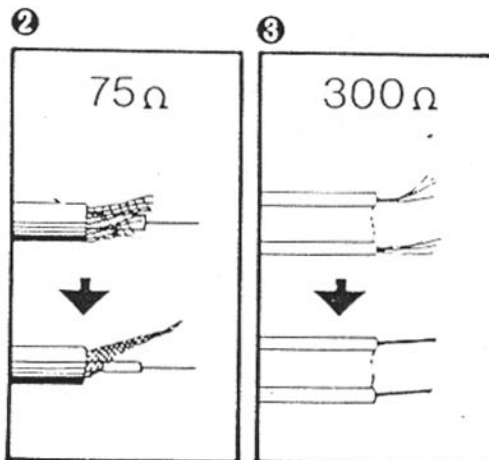
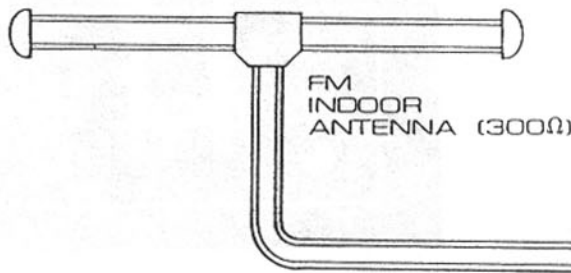
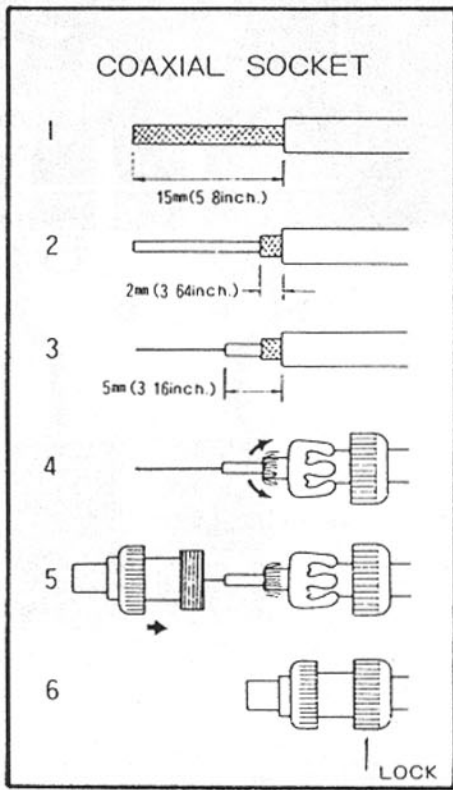

## ● AC OUTLET

### ● NOT AVAILABLE FOR U.K., SCANDINAVIA AND SOME OTHER COUNTRIES

The convenient AC outlets on the rear panel provide power to components you may wish to connect to the unit. Note an outlet marked SWITCHED has power controlled by the power switch of the unit, and one marked UNSWITCHED has power always available not affected by the power switch.

Caution: Do not connect components whose total power consumption exceed rated maximum wattage marked beside the AC outlet.

## ● POWER SUPPLY

- For power the unit requires the normal house AC electrical current (wall outlet). Before connecting up ensure that the unit has a suitable plug fitted. If in any doubt about connecting to the power source, consult a qualified electrician.

### EXCLUSIVE NOTE FOR U.K.

If your unit comes with a 3-core cable without a plug, make certain live, neutral and (where appropriate) earth leads are connected to the proper terminals.

Check that the terminals are screwed down firmly and no loose strands of wire are present.

**WARNING: THIS APPARATUS MUST BE EARTHED.**

**IMPORTANT:** The wires in this mains lead are coloured in accordance with the following code:

GREEN/YELLOW	:	EARTH
BLUE	:	NEUTRAL
BROWN	:	LIVE

As the colours of the wires in the mains lead of this apparatus may not correspond with the coloured markings identifying the terminals in your plug proceed as follows.

The wire which is coloured GREEN/YELLOW must be connected to the terminal in the plug which is marked by the letter E or by the safety earth symbol  $\perp$ , or coloured GREEN/YELLOW.

The wire which is coloured BLUE must be connected to the terminal which is marked with the letter N or coloured BLUE or BLACK. The wire which is coloured BROWN must be connected to the terminal which is marked with the letter L or coloured BROWN or RED.

The apparatus must be protected by a 3 Amp fuse if a 13 Amp (BS 1363) plug is used. If another type of plug is used a 5 Amp fuse or lower must be used, either in the plug or adapter or at the distribution board.

## ● PRE AMP OUT AND MAIN AMP IN RECEPTACLES

- These receptacles are intended for use when you wish to operate pre-amplifier/tuner and main-amplifier sections of this unit separately such as connecting another pre-amplifier or main-amplifier, or to connect appropriate auxiliary component such as audio equalizer in between.

### NORMAL POSITION

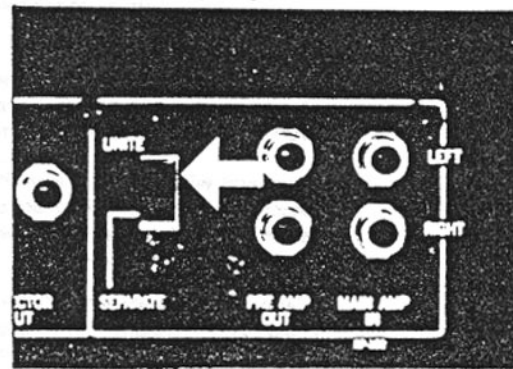

# ● COMPONENTS CONNECTION

SENSITIVITY SWITCH (PHONO-1)

INPUT SENSITIVITY OF YOUR CARTRIDGE

HIGH (2.4mV)	for the range of 1mV-4mV
LOW (6.4mV)	for the range of 5mV-8mV

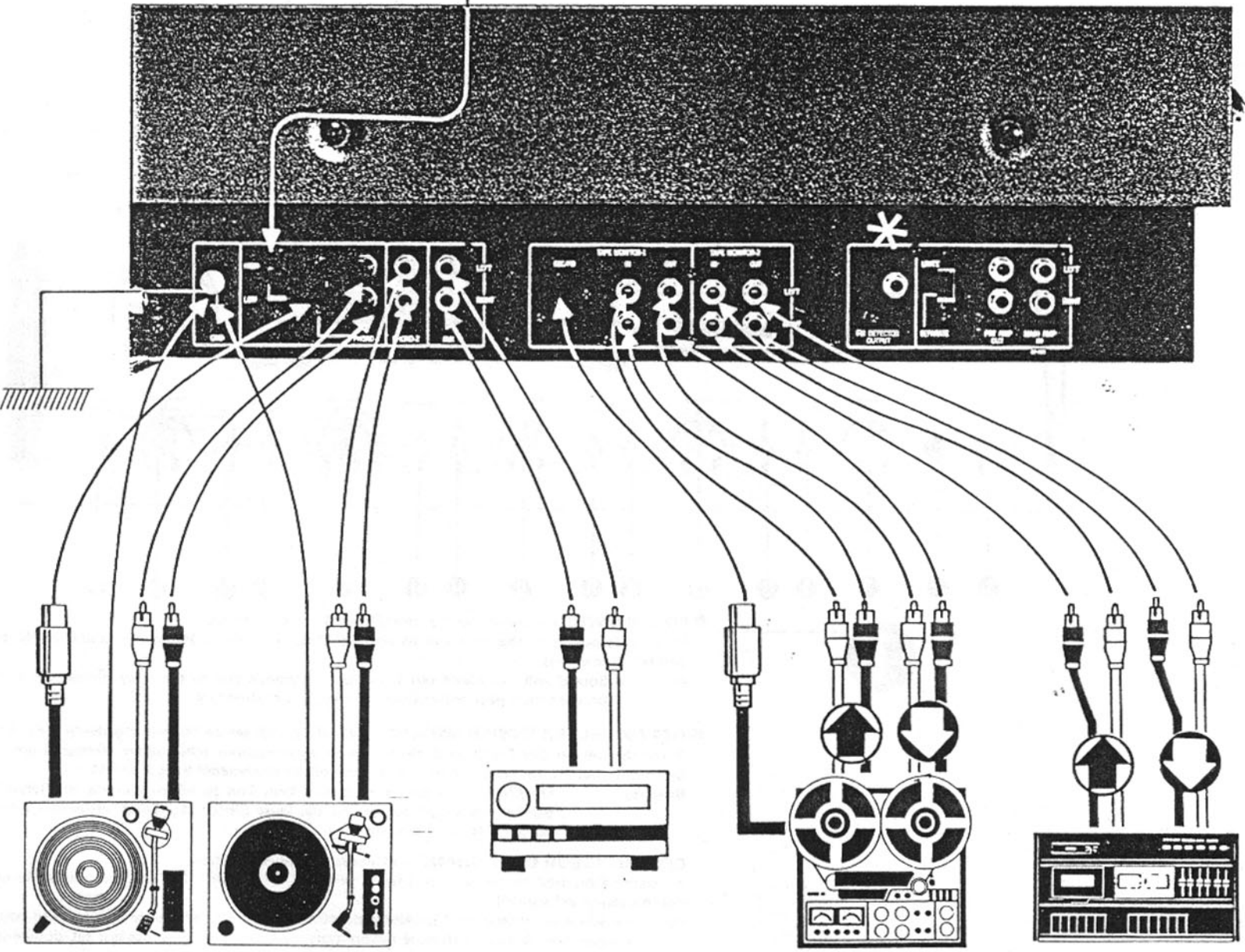

DIN TYPE PLUG	RIGHT LEFT	INPUT-OUTPUT	TURN TABLE	TAPE DECK	TAPE DECK	8 TRACK PLAYER	GROUND

## \* FM-4 CHANNEL DETECTOR OUTPUT

Use to accept an adapter to enable receive 4-channel broadcasting whenever effected in the future.

# ● SWITCH AND CONTROLS

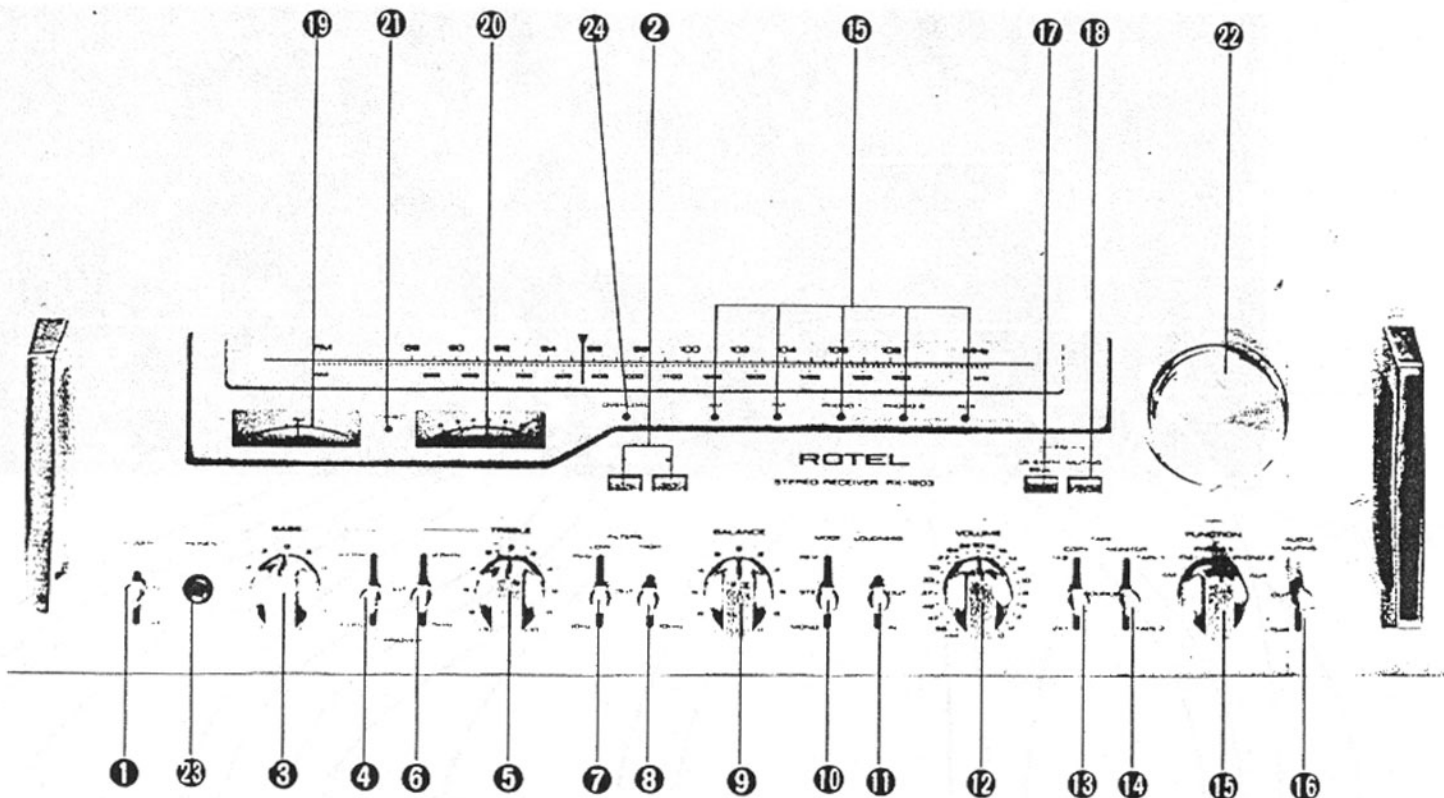

**1**

● **POWER SWITCH** — performs the function as its name denotes. It supplies power to the unit and to any switched AC outlets. When the switch is ON the dial light will be illuminated.  
 Note: Sound will not come out for about 7 seconds due to the relay protection circuit used to prevent loud pop noise when the switch is pushed ON.

2

## ● SPEAKER CONTROL

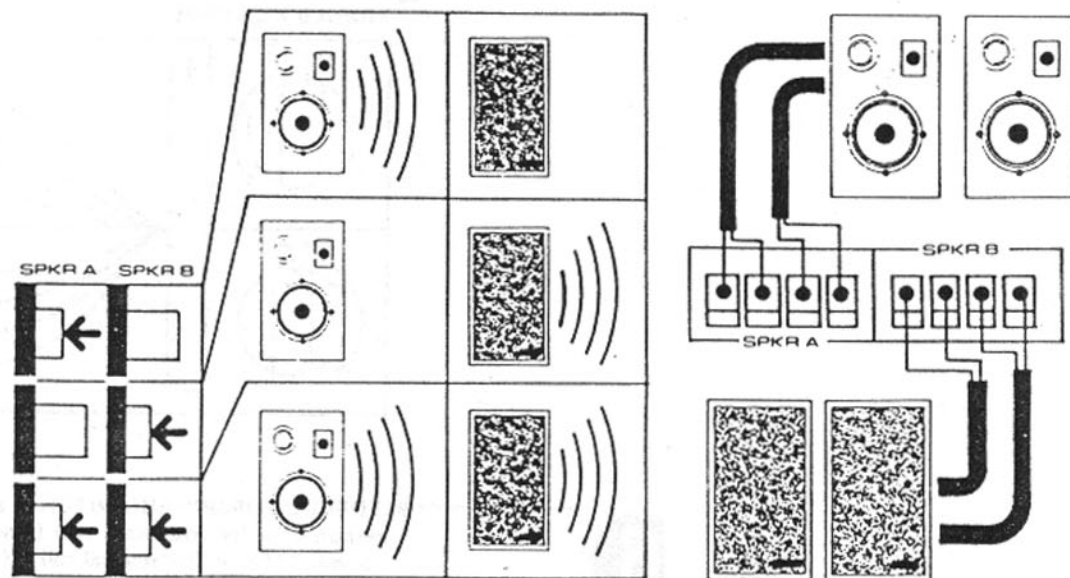

3

## ● BASS CONTROL

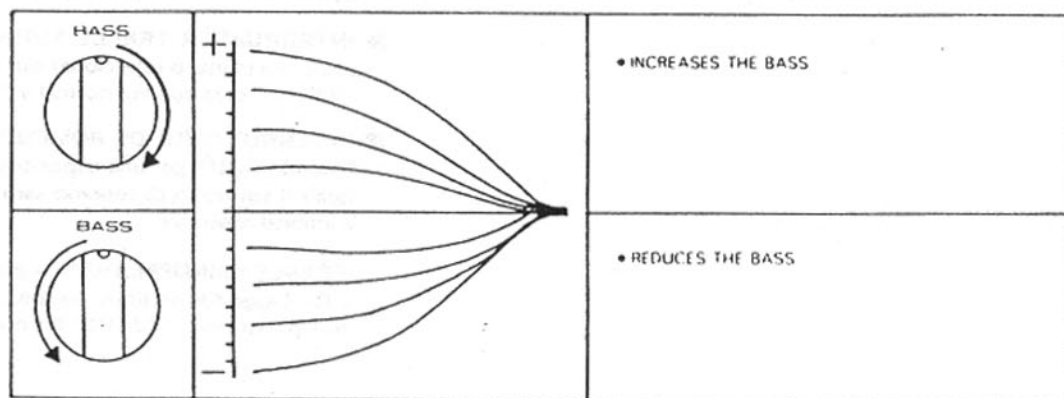

4

- **BASS TURNOVER SWITCH** — allows you to defeat the bass control by setting at OUT, or let you select two frequency ranges (so-called roll-off curves) at low frequencies at which bass control will be effected. "400Hz" for normal roll-off and "200Hz" for roll-off at lower range.

5

## ● TREBLE CONTROL

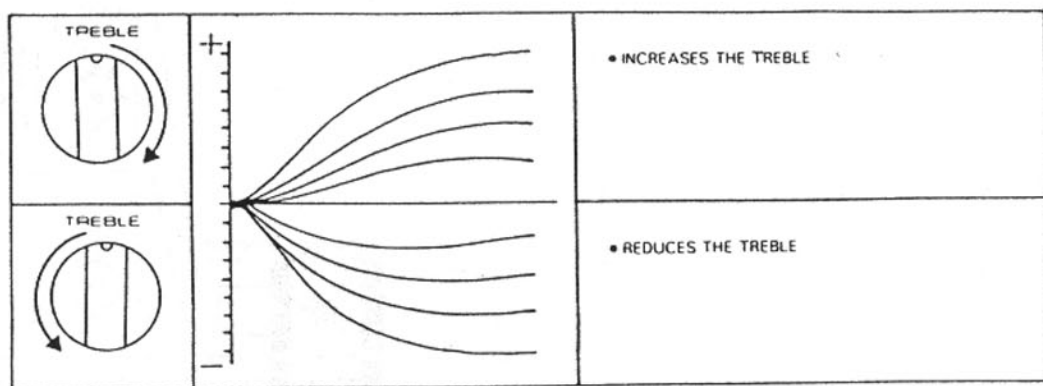

6

- **TREBLE TURNOVER SWITCH** — allows you to defeat the treble control by setting at OUT for a flat response, or let you select two frequency ranges at high frequencies at which treble control will be effected. "2.5kHz" for normal roll-off and "5kHz" for roll-off at higher range.

7

- **LOW FILTERS** — allows you to reduce the low frequency response whenever you wish to minimize annoying record and tape rumbles, etc. "30Hz" is for normal cut, and "15Hz" is actually a subsonic filter which cuts out undesirable noise characteristics which may exist on subsonic frequencies. However, normally leave the switch OUT for optimum frequency-reproduction.



8

- **HIGH FILTER** — Allows you to reduce high frequency interference whenever you wish to eliminate annoying record scratches, tape hiss, FM background noise, etc. Normally, however, keep this switch **OUT**

9

- **BALANCE CONTROL**

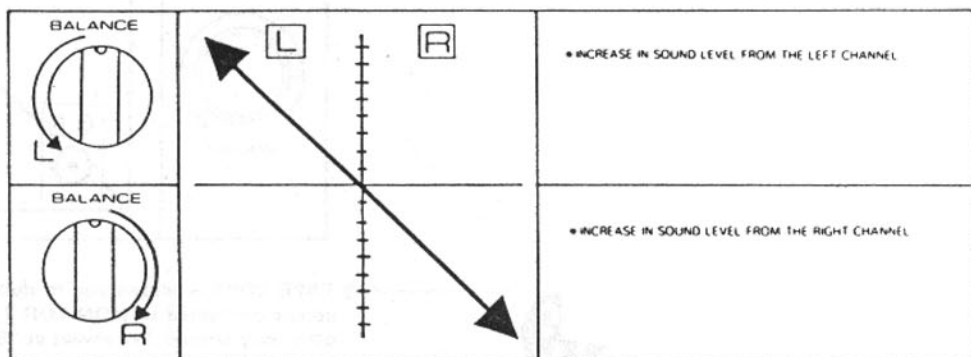

10

- **MODE CONTROL**

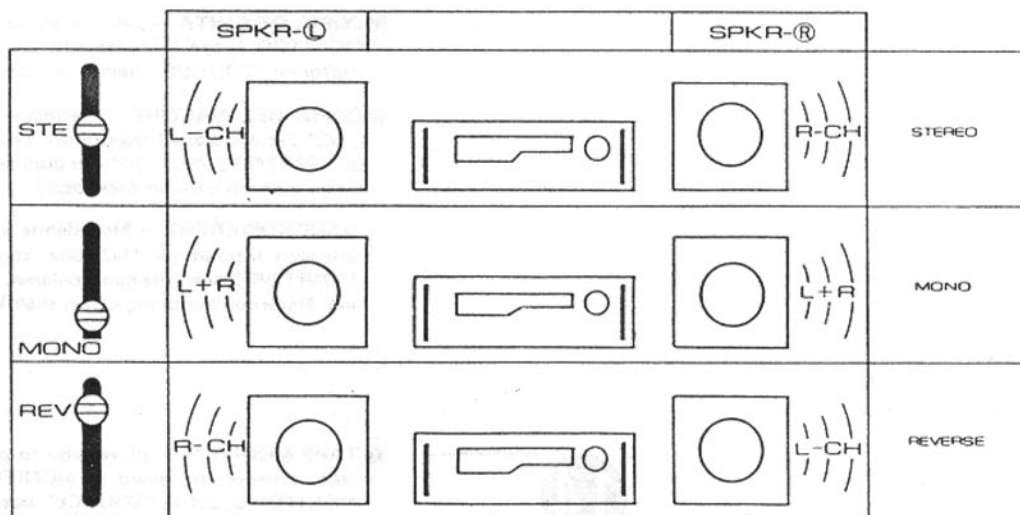

11

- **LOUDNESS SWITCH** — allows you to boost low and high frequencies at low listening levels. Leave the switch **OUT** at normal or high volume settings.

12

- **VOLUME CONTROL**

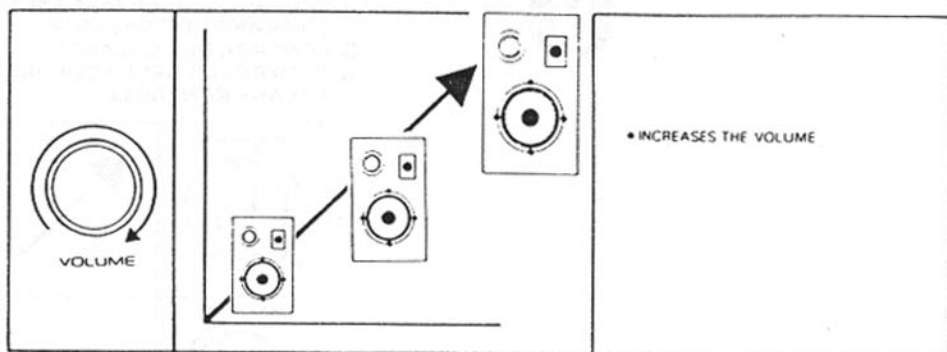

13

- **TAPE COPY** — allows you to dub (record each other) two tape recorders. "1-2" to dub the tape recorder connected to MONITOR 1 by the tape recorder connected to MONITOR 2; "2-1" to dub the other way around. Set always at "SOURCE" position when not dubbing.

14

- **TAPE MONITOR** — allows you to playback and monitor the tape recorders. TAPE 1 to playback the tape recorder connected to MONITOR 1 and TAPE 2 to playback the tape recorder connected to MONITOR 2. Set to "SOURCE" position whenever tape recorder is not being played but other material is being played.

15

● FUNCTION SELECTOR SWITCHES

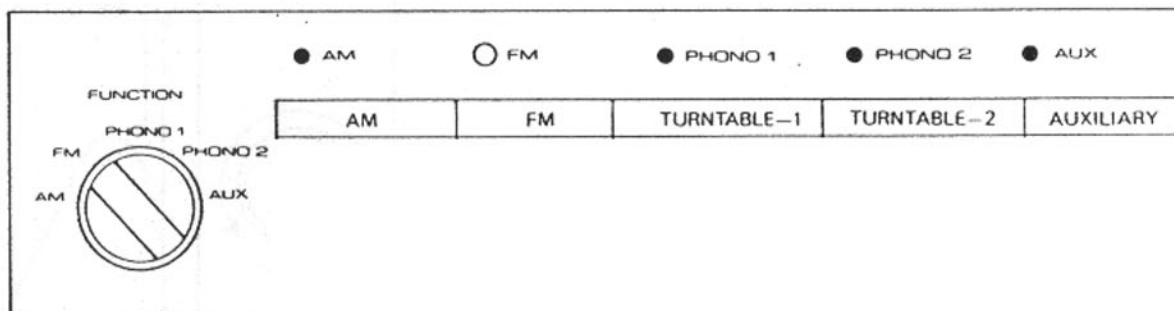

16

● **AUDIO MUTING SWITCH** — allows you to reduce the level of volume by -15db for momentary quieting when you do not wish to change the volume setting but must lower volume temporarily.

17

● **FM 25 $\mu$ s DE-EMPHASIS SWITCH** —allows you to set this unit to proper de-emphasis level of FM reception, when you wish to connect Dolby noise reduction adapter to this tuner and listen to Dolby FM broadcasting.

18

● **FM MUTING SWITCH** — allows you to reduce audible interstation noise when turning from station to station in FM.  
Leave the switch OFF when you wish to pick up a very weak station.

19

● FM TUNING METER

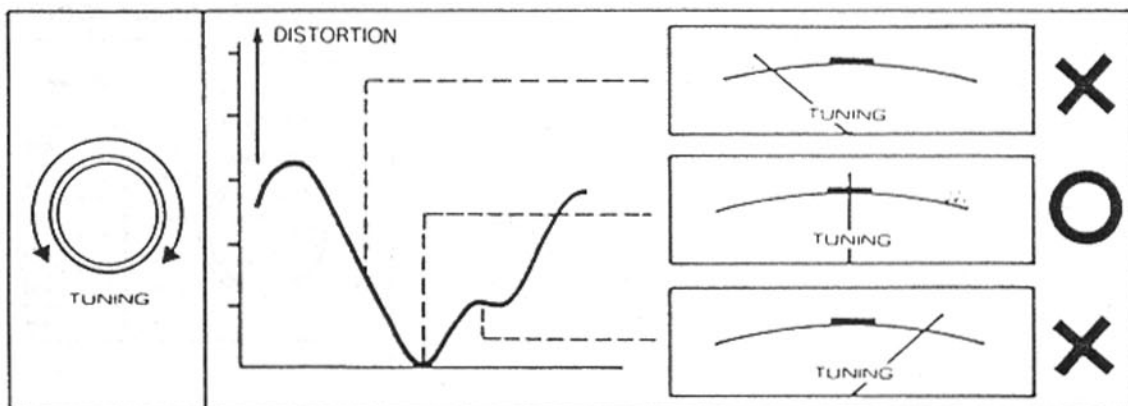

20

● SIGNAL STRENGTH TUNING METER

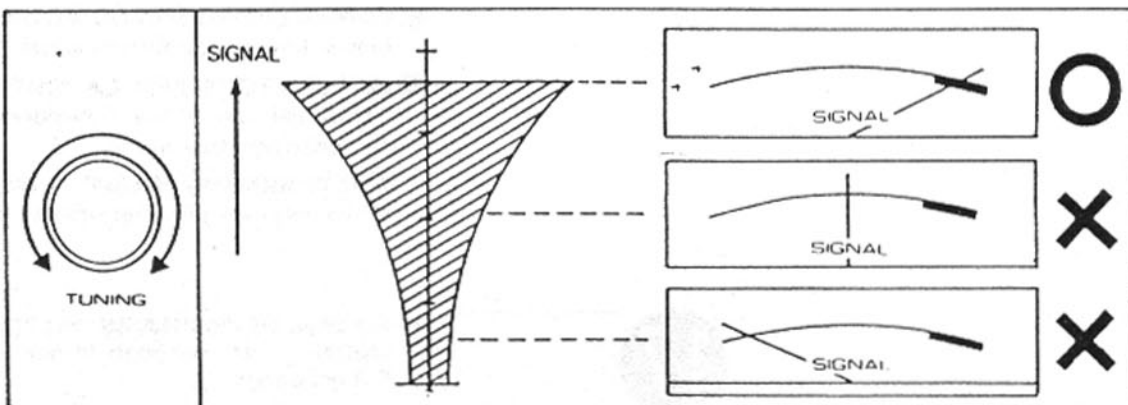

21

● **STEREO INDICATOR LIGHT** — automatically lights up on the dial glass to visually indicate whenever an FM stereo broadcast is tuned.

22

● TUNING KNOB

23

● HEADPHONES RECEPTACLE

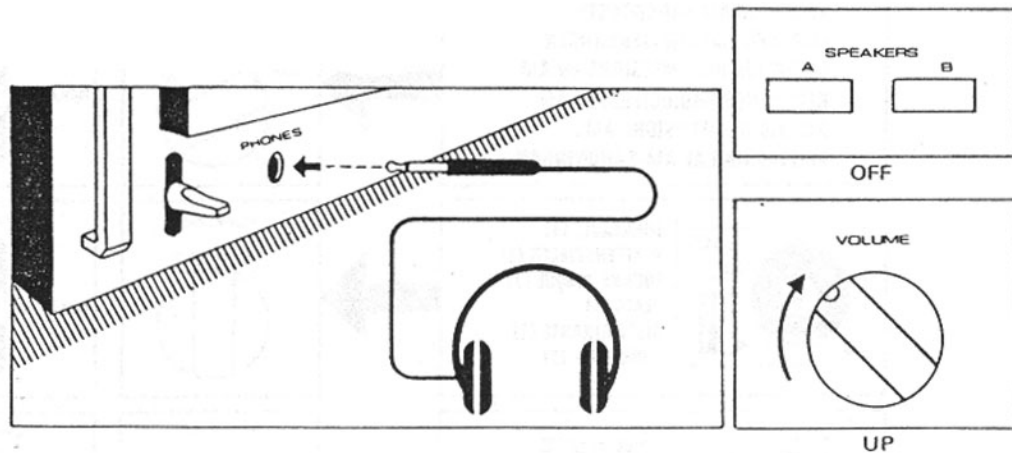

24

● OVERLOAD INDICATOR — lights up when the speakers are shorted or the unit overloaded. Turn the power switch OFF and check the speaker connections or other causes of overload. Note the unit will not operate unless the power switch is cut OFF first and re-pushed ON.

## ● OPERATION

● Having made all connections according to the preceding instructions and become familiar with the functions of the unit, you are ready to operate the equipment. Apply power by plugging into the power source and pushing in the POWER switch.

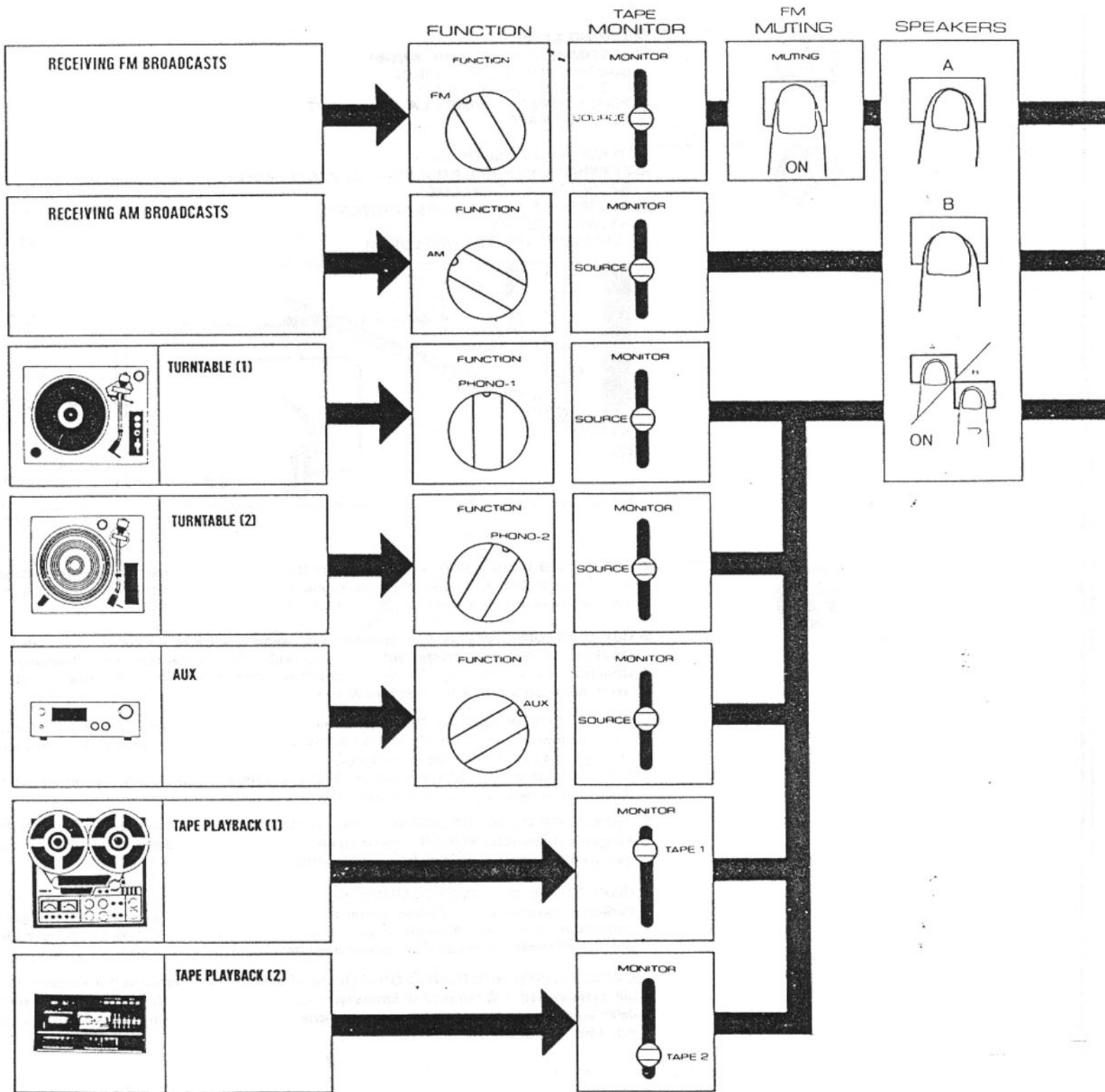

● About 7 seconds after switching on POWER:  
Speaker switch is electronically activated by relay.

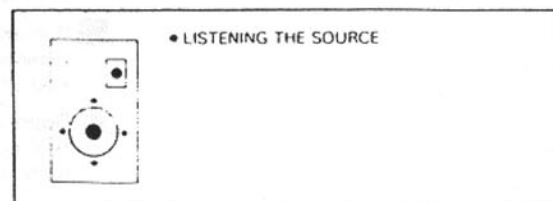
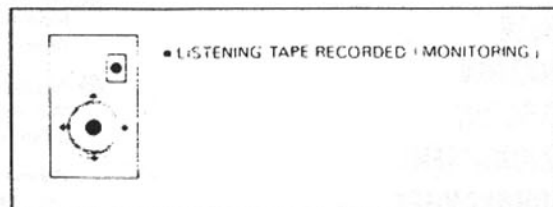

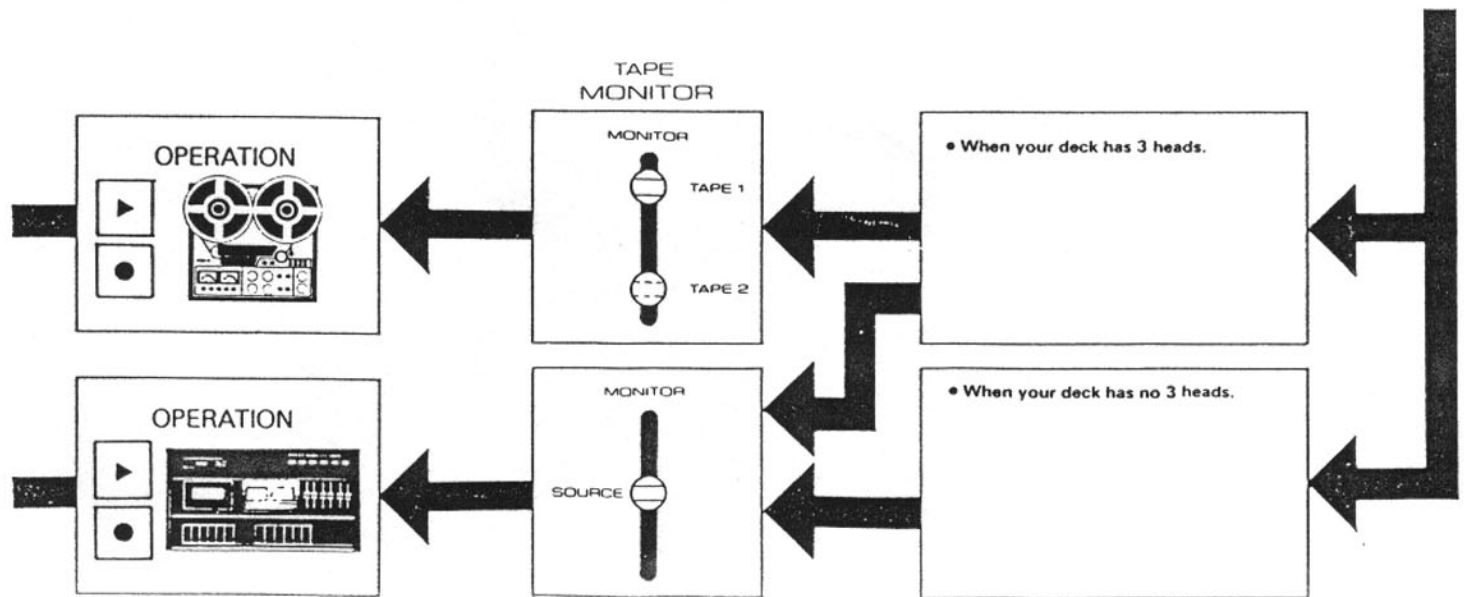
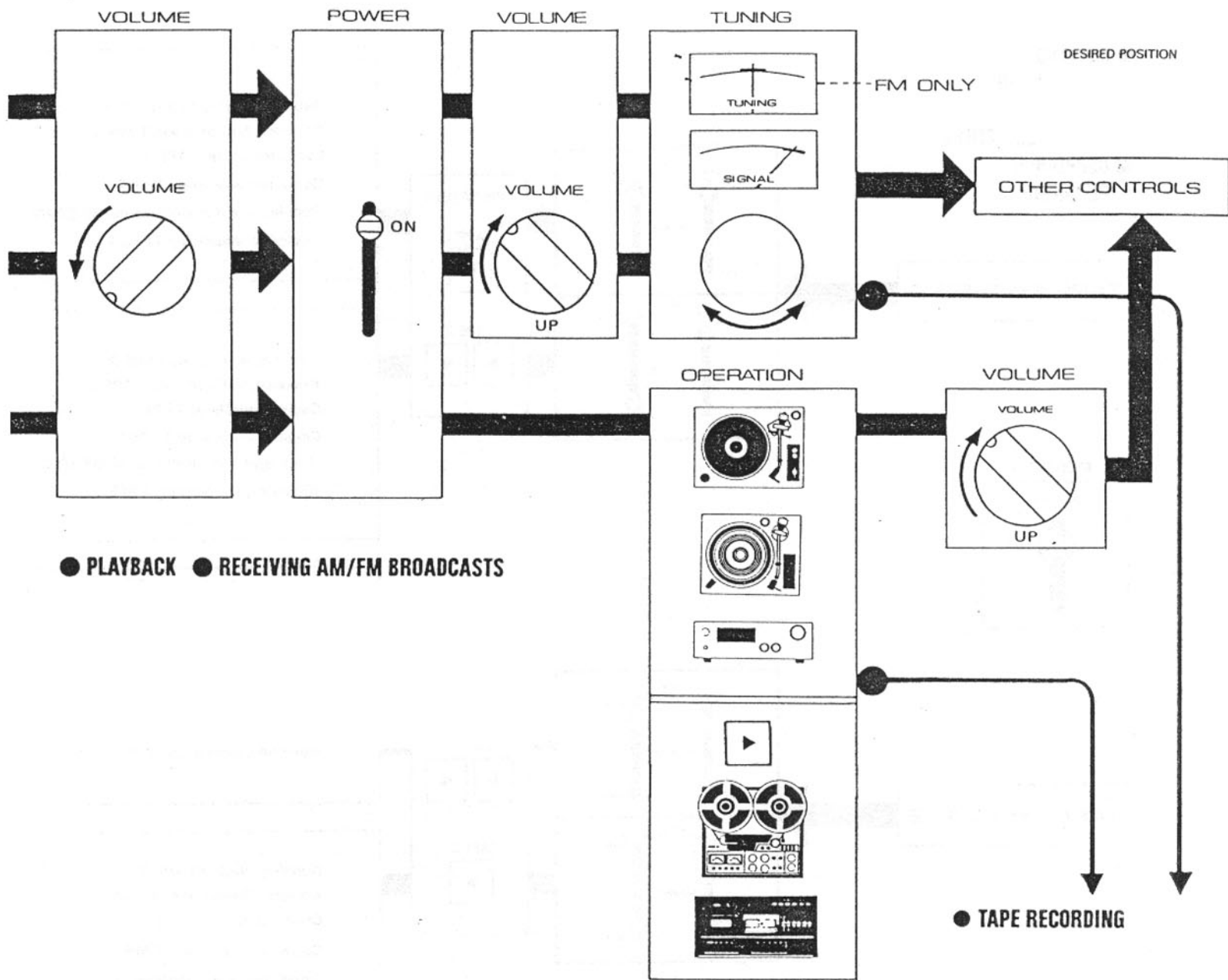

## ● DUBBING

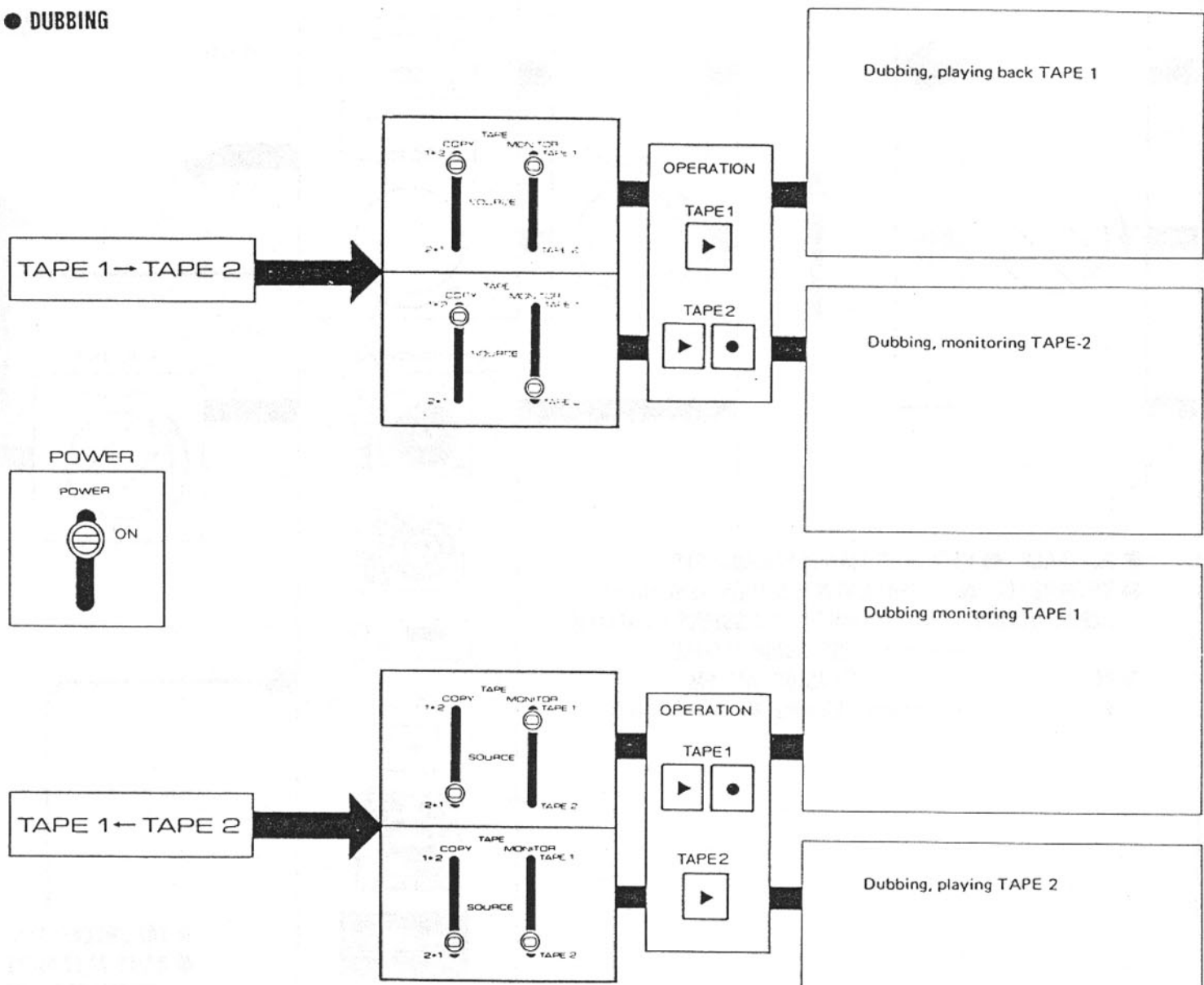

## ● PROTECTION

- This equipment is protected by a special electronic resettable protection circuit and the fuses installed inside the chassis. If the unit fails to operate when plugged in and turned on or if it suddenly becomes completely inoperative while playing (i.e. one or both speakers are silent regardless of speaker switches and function selector control position), the protection circuit is probably activated due to an overload condition such as shorting by stranded speaker wires at the speaker terminals. Once the fault is found and corrected, the protection circuit will be deactivated by resetting and the unit will work.

Caution: If the unit does not operate, or if it becomes inoperative within a short time, consult your dealer or a ROTEL service center.

## ● HUM AND NOISE

- In any high fidelity installation, hum may be caused by the interconnection of a record player, tuner and amplifier, and speakers as result of the cables, different grounds or locations of components. If hum is experienced with your unit, disconnect everything but the speakers from the unit. If the hum persists, reverse the power plug at the power source. Plug in the record player and if hum or howling appears, move the record player away from the speakers as much as possible. Note hum may also be induced by defective connection cables or by running these cables too close to a strong AC field. When your unit picks up noise during the reception of broadcasts, causes are mostly due to external objects such as fluorescent lamps and house appliances using motor or thermostat, or others that may induce the noises. Either relocating the unit away from the noise sources or using an improved outdoor antenna may readily solve the problem. In the event you cannot find the causes, consult your dealer or a qualified electrician.

## ● VOLTAGE SELECTION

- Not available for U.K., Canada and Scandinavia

The receiver is a variable voltage equipment that can run on 100V, 117V, 220V or 240V power supply. Your unit comes already preset at the proper voltage for use in your area, however, if you move to an area where the power supply voltage is different, the voltage setting can be manually changed.

**BE SURE THAT YOUR UNIT IS NOT CONNECTED TO THE POWER SOURCE BEFORE ATTEMPTING TO MAKE THIS CHANGE.**

To change the voltage setting, remove the name plate on the rear panel and locate the VOLTAGE SELECTOR (see figure left). Pull up the voltage selector plug which has a white arrow on its top. Re-insert the plug to the selector base so that the head of the arrow lines up with the pointer line of the voltage you desire.

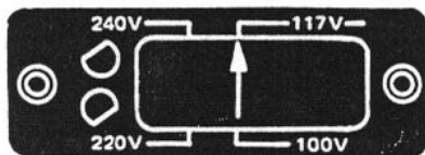

# ● SPECIFICATIONS

## POWER AMPLIFIER SECTION:

### Continuous Power Output:

120watts\* per channel, min. RMS both channels driven at 8 ohms from 20 to 20,000Hz with no more than 0.05% total harmonic distortion.

Total Harmonic Distortion . . . . .	No more than 0.05%
(20 to 20,000Hz, from AUX)	(continuous rated power output)
	No more than 0.03%
	(1 watt per channel power output, 8 ohms)
Intermodulation Distortion . . . . .	No more than 0.1%
50Hz: 7,000Hz=4:1	(continuous rated power output)
from AUX)	No more than 0.06%
	(1 watt per channel power output, 8 ohms)
Frequency Response . . . . .	.5Hz to 100,000Hz
	+0dB, -1dB
	(1 watt per channel power output, 8 ohms)
Input Sensitivity/Impedance. . . . .	0.8 V/50 Kohms (MAIN AMP IN)
Damping Factor. . . . .	50 (20 to 20,000Hz, 8 ohms) ±10%

## PREAMPLIFIER SECTION

### Input Sensitivity/Impedance:

PHONO 1 . . . . .	2, 6mV/50 Kohms
PHONO 2 . . . . .	2, 6mV/50 Kohms
AUX . . . . .	150mV/50 Kohms
TAPE IN 1 . . . . .	150mV/50 Kohms
TAPE IN 2 . . . . .	150mV/50 Kohms
TAPE IN 1 (DIN connector). . . . .	150mV/50 Kohms
Overload Level [Maximum Input Level] (T.H.D. 0.05%, 1kHz)	
PHONO 1 . . . . .	350mV (2mV input)
PHONO 2 . . . . .	350mV (2mV input)
AUX . . . . .	Not less than 12V

### Output Level/Impedance (5mV PHONO input):

TAPE OUT 1 . . . . .	330mV/2.2 Kohms
TAPE OUT 2 . . . . .	330mV/2.2 Kohms
TAPE OUT 1,2 . . . . .	100mV/80 Kohms (DIN connectors)
PRE OUT . . . . .	0.8V/3 kohms

Total Harmonic Distortion. . . . . No more than 0.01%  
(20Hz to 20,000Hz, 0.8V output)

### Frequency Response:

PHONO . . . . .	30Hz to 15,000Hz ±0.2dB (RIAA Equalization)
-----------------	--

### Tone Control:

BASS . . . . .	±10dB (100Hz)
TREBLE . . . . .	±10dB (10kHz)

### Filter:

SUBSONIC . . . . .	15Hz (12dB/oct.)
LOW . . . . .	30Hz (12dB/oct.)
HIGH . . . . .	8 kHz (12dB/oct.)

Loudness Contour . . . . . +8dB (100Hz), +5dB (10kHz)

### Hum & Noise (IHF, short circuited A network, rated power):

PHONO . . . . .	75dB
AUX, TAPE IN . . . . .	95dB

Audio Muting . . . . . -15dB

## FM TUNER SECTION

Usable Sensitivity . . . . .	8.8dBf (1.5μV/300 ohms)
Usable Sensitivity (IHF '58). . . . .	1.5μV
50dB Quieting Sensitivity: . . . . .	MONO 15dBf (3.0μV/300 ohms)
	STEREO 34.7dBf (30μV/300 ohms)

### Signal-to-Noise Ratio (at 65dBf):

Mono . . . . .	80dB
Stereo . . . . .	70dB

### Distortion (at 65dBf):

100Hz . . . . .	0.1% (mono), 0.3% (stereo)
1kHz . . . . .	0.1% (mono), 0.2% (stereo)
6kHz . . . . .	0.2% (mono), 0.3% (stereo)

Frequency Response . . . . . 30Hz to 15,000Hz +0.3dB, -1dB

Capture Ratio . . . . .	1.0dB
Alternate Channel Selectivity . . . . .	80dB
Spurious Response Ratio. . . . .	110dB
Image Response Ratio . . . . .	100dB
IF Response Ratio . . . . .	110dB
AM Suppression Ratio . . . . .	60dB
Stereo Separation . . . . .	45dB (1kHz), 35dB (30Hz to 15kHz)

## AM TUNER SECTION

Sensitivity . . . . .	250μV/m (IHF, ferrite antenna), 12.5μV/m (IHF, ext. antenna)
-----------------------	---

## MISCELLANEOUS

Power Consumption. . . . .	1200watts (Max.)
Dimensions (Overall) . . . . .	580(W) x 180(H) x 510(D)mm
Weight (Net). . . . .	22.7kg (50lbs)

NOTE. Specifications and design subject to possible modification without notice.

\*Measured pursuant to the Federal Trade Commission's Trade Regulation Rule on Power Claims for Amplifiers.  
(Applicable to the U.S.A. only)